

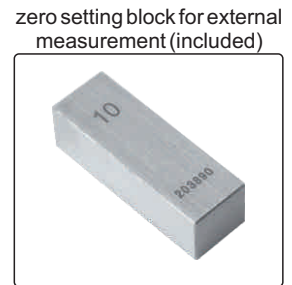

- ◆ Supplied with 4 pairs of points
(Cylindrical needle point: 270-006-16 2pc,
Cylindrical needle point: 270-006-04 2pc,
Conical needle point: 270-006-21 2pc,
Conical needle point: 270-006-23 2pc)
- ◆ Zero setting block for external measurement
- ◆ Resolution: 0.01mm/0.0005"
- ◆ Buttons: on/off, mm/inch, ZERO
- ◆ Automatic power on/off
- ◆ Data output (cable code: 100-11 or 100-12)
- ◆ Made of stainless steel

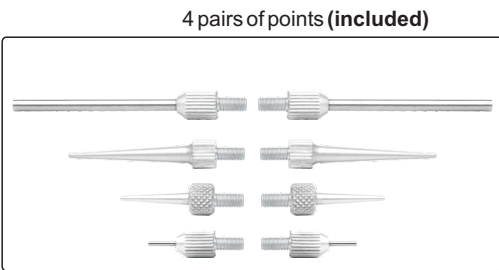

Measure internal and external grooves

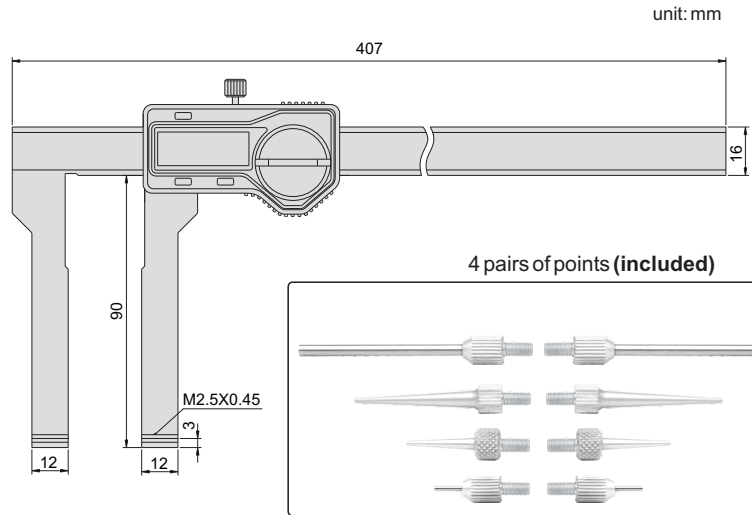
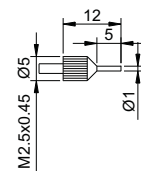
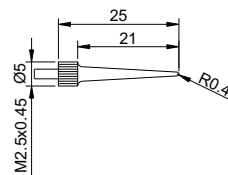
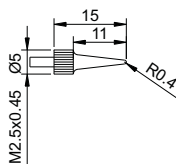
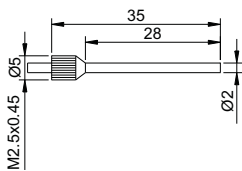
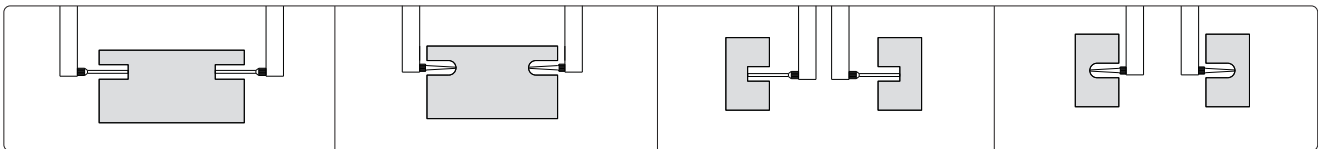

Code	Range	Accuracy
149-012-21	0-300mm/0-12"	±0.04mm